

**GENERIC DRAWING; CONTACT ASCENSION FOR PROJECT-SPECIFIC DRAWINGS**

SEE OTHER CLARITY LIFT MODELS (16C, 16D, 16E, ETC.) FOR OTHER ENTRY/EXIT AND ENCLOSED/SHAFTWAY OPTIONS  
 SEE OPTIONS BROCHURE AND/OR SHEET 3 FOR VARIOUS CONFIGURATION OPTIONS

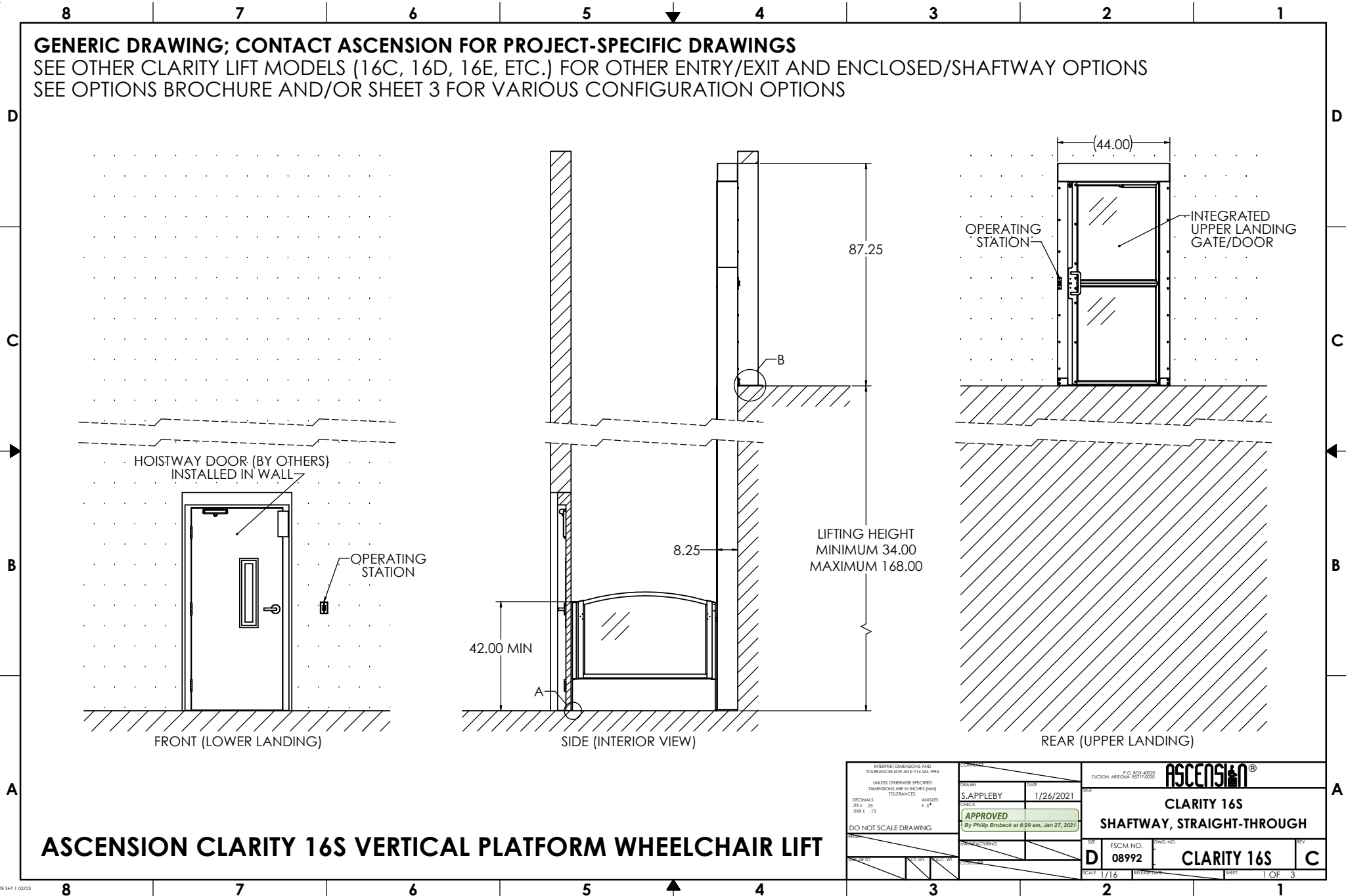

**ASCENSION CLARITY 16S VERTICAL PLATFORM WHEELCHAIR LIFT**

<small>INTERPRET DIMENSIONS AND TOLERANCES IN ACCORDANCE WITH ASME Y14.5M-1994 UNLESS OTHERWISE SPECIFIED DIMENSIONS ARE IN INCHES (MM) TOLERANCES ANGLES</small> <small>DECIMALS .005 .01 .03 .04 .05 .06 .07 .08 .09 .10 .15 .20 .25 .30 .35 .40 .45 .50 .60 .70 .80 .90 .95 .99 .995 .999 .9995 .9999</small> <small>DO NOT SCALE DRAWING</small>		<small>DATE</small> 1/26/2021	<small>SCALE</small> 1/16"	<small>RELEASED BY</small> PHILIP BROBECK	<small>DATE</small> 1/26/2021	<small>SCALE</small> 1/16"	<small>RELEASED BY</small> PHILIP BROBECK	ASCENSION® F.O. BOX 4000 TUCSON, ARIZONA 85717-0000
DRAWN BY S. APPLEBY		CHECKED BY PHILIP BROBECK	APPROVED BY PHILIP BROBECK	APPROVED BY PHILIP BROBECK	APPROVED BY PHILIP BROBECK	APPROVED BY PHILIP BROBECK	APPROVED BY PHILIP BROBECK	CLARITY 16S SHAFTWAY, STRAIGHT-THROUGH
FSCM NO. 08992	DWG. NO. CLARITY 16S	SHEET 1 OF 3	SCALE 1/16"	RELEASED BY PHILIP BROBECK	DATE 1/26/2021	SCALE 1/16"	RELEASED BY PHILIP BROBECK	CLARITY 16S

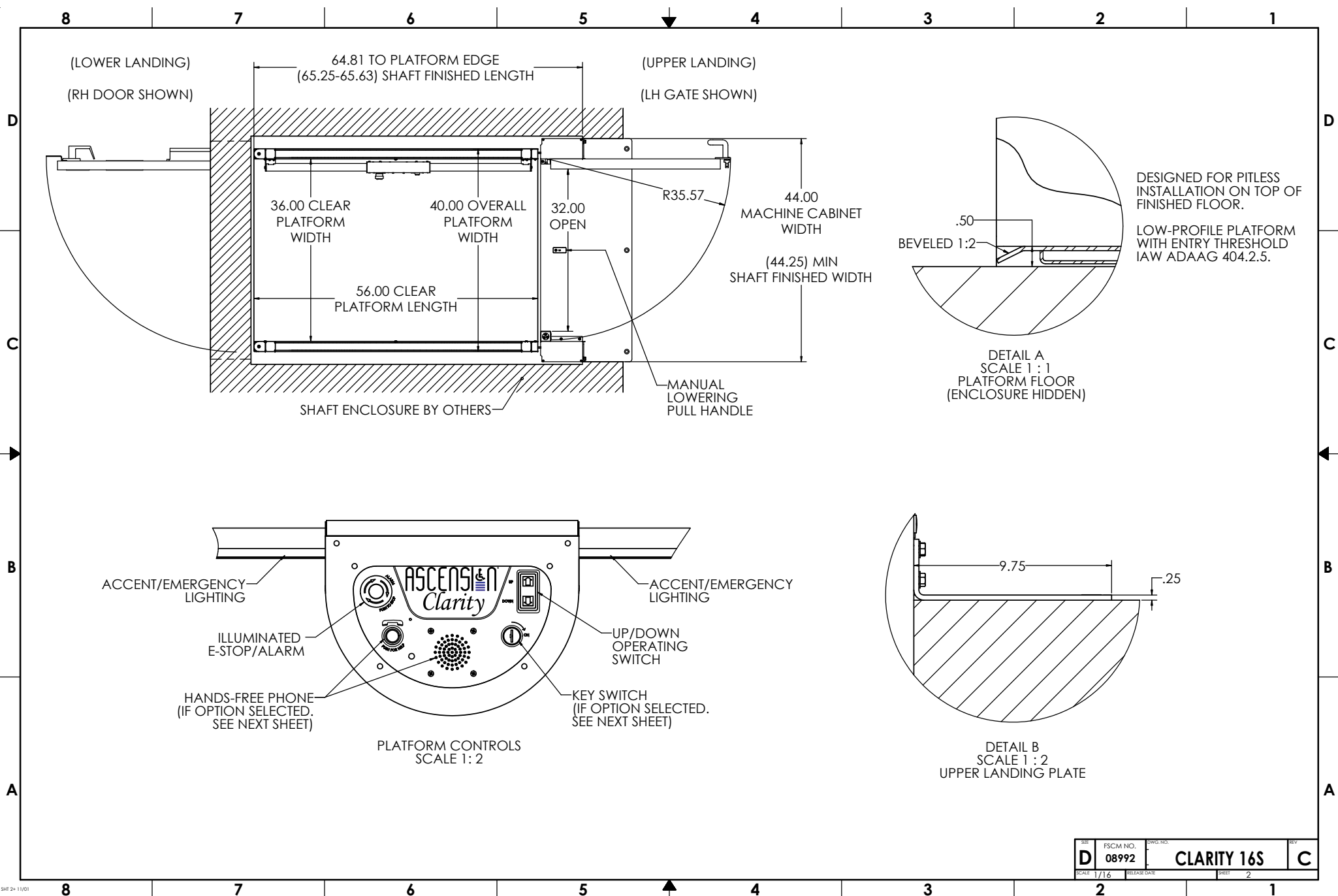

REV	FSCM NO.	DWG. NO.	REV
D	08992	CLARITY 16S	C
SCALE 1/16	RELEASE DATE	SHEET 2	

8 7 6 5 4 3 2 1

**CONFIGURATION**

TOTAL TRAVEL	34" TO 168"
ENTRY/EXIT CONFIG.	STRAIGHT THROUGH
ENCLOSURE PROVIDED	NONE (BY OTHERS)
DOVE/VENTILATION	YES/NO

<b>LOWER LANDING</b>	
DOOR TYPE	HOISTWAY DOOR (BY OTHERS)
HANDING	RH/LH
DOOR OPERATOR	YES/NO
CALL STATION TYPE	WALL MOUNT
CALL STATION KEYED	YES/NO

<b>UPPER LANDING</b>	
DOOR TYPE	46.5" GATE/ 80" DOOR
HANDING	RH/LH
DOOR OPERATOR	YES/NO
CALL STATION TYPE	WALL/FRAME MOUNT
CALL STATION KEYED	YES/NO

<b>PLATFORM</b>	
KEY SWITCH	YES/NO
HANDS-FREE PHONE	YES/NO
PLATFORM LIGHTING	STANDARD

COLOR	SILVER/CUSTOM
LOCATION	OUTDOOR/INDOOR
OUTDOOR PACKAGE	YES/NO
PIT SWITCH	YES/NO
MANUAL LOWERING	STANDARD
AUDIBLE ALARM	STANDARD
BATTERY BACKUP	STANDARD

**SPECIFICATIONS**

DESCRIPTION	SHAFTWAY VERTICAL PLATFORM WHEELCHAIR LIFT
CODE COMPLIANCE	ASME A18.1, ASME A17.5, NFPA 70 (NEC), ANSI A117.1, ADASAD (ADAAG)

APPLIED VERSION	ASME A18.1-2017
MODEL	CLARITY 16S
RATED LOAD	750 LB
RATED SPEED	20 FT/MIN
DUTY CYCLE	168 CYCLE-FT/HR (12 CYCLES/HR MINIMUM)
PLATFORM SIZE	36" X 56"
POWER SUPPLY	27VDC, 500W (18.5A)
BATTERIES	12V, 35A-h AGM SLA (2X)
CONTROL SYS.	24VDC
MOTOR	24VDC, 3 HP
DRIVING MEANS	2:1 CHAIN-HYDRAULIC

PLUNGER (2X)	1.25" SOLID
CYL. I.D. (2X)	2.00"
CYL. O.D. (2X)	2.38"
STROKE (2X)	(VARIES)

WORKING PSI	400 PSI
RELIEF PSI	600 PSI (1.5 X WP)

CHAIN TYPE	4X ANSI #50 ROLLER CHAIN
CHAIN STRENGTH	5045 LBF EACH
SAFETIES	2X TYPE A

DOOR LOCKS	IDEC HS5E/HS5L
------------	----------------

WINDOWS	PLEXIGLAS
---------	-----------

**PROVISIONS BY OTHERS**

**GENERAL**

**HOISTWAY:** HOISTWAY MUST BE SQUARE AND PLUMB WITHIN ±1/8" TO ENSURE PROPER LIFT OPERATION. SHAFT DIMENSIONS PROVIDED FOR REFERENCE ONLY. HOISTWAY MUST MEET ASME A18.1 AND ALL APPLICABLE STATE AND LOCAL CODES. HOISTWAY IS TO BE PROVIDED BY OTHERS.

**DOORS:** INSTALLATION OF DOORS TO MEET ALL APPLICABLE CODES. HOISTWAY DOORS TO BE PROVIDED BY OTHERS (SEE ATTACHED FOR RECOMMENDATION).

**REAR CABINET CLOSURE:** VERTICAL SURFACE BEHIND MACHINE CABINET SHALL HAVE STRENGTH AND STIFFNESS EQUIVALENT TO 14GA (.08) SHEET STEEL.

**DIMENSIONS:** TOTAL TRAVEL HEIGHT MUST BE WITHIN ±3/8" OF NOMINAL. VERIFY ALL DIMENSIONS AND IMMEDIATELY REPORT ANY DISCREPANCIES.

**PIT/RAMP:** DO NOT PROVIDE PIT OR RAMP. LIFT DESIGNED WITH LOW-PROFILE PLATFORM FLOOR FOR DIRECT ENTRY IAW ADAAG 404.2.5.

**OVERHEAD CLEARANCE:** MUST COMPLY WITH ALL APPLICABLE CODES.

**CONSTRUCTION COORDINATION:** OWNER/AGENT RESPONSIBLE FOR ALL MASONRY, CARPENTRY, DRYWALL, PATCHING, AND FINISHING WORK NEEDED PRIOR TO AND FOLLOWING LIFT INSTALLATION.

**STRUCTURAL:** SUPPORTING STRUCTURE SHALL BE DESIGNED AND CONSTRUCTED TO SAFELY SUPPORT APPLIED LOADS IN ACCORDANCE WITH "CLARITY LOADING" DIAGRAM.

**ELECTRICAL**

**GENERAL:** ALL WIRING SHALL COMPLY WITH NFPA 70 (NEC).

**POWER:** 120VAC, 60HZ, 6A, 1PH CIRCUIT WITH DISCONNECT (SEE BELOW).

**CONCEALED REAR ACCESS:** CLEAR SPACE 7.25" X 7.50" (W x H) BEHIND LIFT AVAILABLE FOR WIRE ENTRY. SPACE CENTERED 10.88" RIGHT OF LIFT CENTERLINE AND NOMINALLY 6.88" ABOVE LOWER LANDING FLOOR.

**SIDE ACCESS:** TWO 1/2-14 NPSM THREADED HOLES ARE PROVIDED ON BOTH SIDES OF THE MACHINE CABINET. HOLES ARE NOMINALLY 2.25" AND 3.50" ABOVE LOWER FLOOR AND 1.00" FROM REAR VERTICAL WALL.

**MAIN DISCONNECT SWITCH:** OTHERS SHALL PROVIDE LOCKABLE FUSED DISCONNECT SWITCH IAW NFPA 70. SWITCH TO INCLUDE ADDITIONAL POLE OR CONTACT FOR DISCONNECTION OF CONTROLLER FROM 24V BACKUP SUPPLY.

**LIGHTING:** 54 LX MIN. AT PLATFORM AND LANDINGS.

**ADDITIONAL AC CONNECTIONS:** ADDITIONAL AC CONNECTIONS REQUIRED FOR: VENTILATION SYSTEM (IF EQUIPPED), 120VAC 1.3A 60HZ 1PH.

DOOR OPERATOR(S) (IF BY OTHERS), POWER REQ. PER MANUFACTURER

**PHONE:** STANDARD PHONE CABLE WITH RJ11 PLUG CONNECTOR REQUIRED FOR OPTIONAL (ANALOG) HANDS-FREE PHONE, WHERE PROVIDED.

REV	FSCM NO.	DWG. NO.	REV
D	08992	CLARITY 16S	C
SCALE	1/16"	SHEET	3

8 7 6 5 4 3 2 1

# CLARITY LOADING - OPPOSING ENTRY & EXIT (16E, 16S)

(GENERIC APPLICATION DEPICTED; ENCLOSURE NOT SHOWN)

MACHINE CABINET ANCHORS				
ANCHORING REQUIREMENT	ANCHOR LOCATION* (±.38) [IN]	# OF ANCHORS	TYPE (NEXT SHEETS)	APPLICABILITY
ANCHOR AT ONE OF TOP LOCATIONS.	UPPER F.F.	3	A	CONCRETE LANDING
	1" BELOW	6	B	WOOD LANDING
OPTIONAL (USE OF OPTIONAL ANCHORS RECOMMENDED FOR MAXIMUM RIGIDITY)	145.50	2	C	TRAVEL > 148.5"
	121.50			TRAVEL > 124.5"
	97.50			TRAVEL > 100.5"
	73.50			TRAVEL > 76.5"
	49.50			TRAVEL > 52.5"
ANCHOR AT ONE OF BOTTOM LOCATIONS	6.00	2	C	ALL LIFTS
	LOWER F.F.	2	D	H.L. PKG ONLY
ENCLOSURE ANCHORS (16E MODEL ONLY)				
REQUIRED IF PRESENT	LOWER F.F.	2	F	16E ONLY

\* ACTUAL LOCATIONS OF WALL ANCHORS MAY VARY AS MUCH AS ±3/8" FROM VALUES GIVEN ABOVE. MOUNTING STRUCTURE MUST BE ABLE TO ACCOMMODATE THIS VARIABILITY.

MAX LOAD PER ANCHOR BY TRAVEL HEIGHT [LBF]**						MAX TOTAL HORIZONTAL LOAD [LBF]** (FORCE ON STRUCTURE)
TRAVEL	ANCHOR TYPE (SEE TABLE ABOVE)					
		A	B	C	D	F
34.0 - 52.5	610	SPECIAL†	949	777	200	2000
52.5 - 76.5	367	188	563	498	200	1250
76.5 - 100.5	242	123	369	339	200	850
100.5 - 124.5	181	91	274	258	200	675
124.5 - 148.5	144	73	218	208	200	550
148.5 - 168.0	120	60	181	174	200	475

\*\* LOADS LISTED ASSUME STATIC LOADING AND DO NOT INCLUDE WIND, SEISMIC, OR SAFETY FACTOR.

† WHEN USED, REQUIRES 6X TYPE B ANCHORS WITH 289 LBF MAX LOAD, 2X TYPE C ANCHORS AT 49.50 LOCATION WITH 185 LBF MAX LOAD, AND ANCHORING AT ONE OF THE BOTTOM LOCATIONS.

### ADDITIONAL NOTES:

- ANCHORS PROVIDED BY ASCENSION FOR COMMON MOUNTING APPLICATIONS. (SEE NEXT SHEETS FOR DETAILS).  
STAINLESS-STEEL CONCRETE ANCHORS PROVIDED FOR OUTDOOR APPLICATIONS.

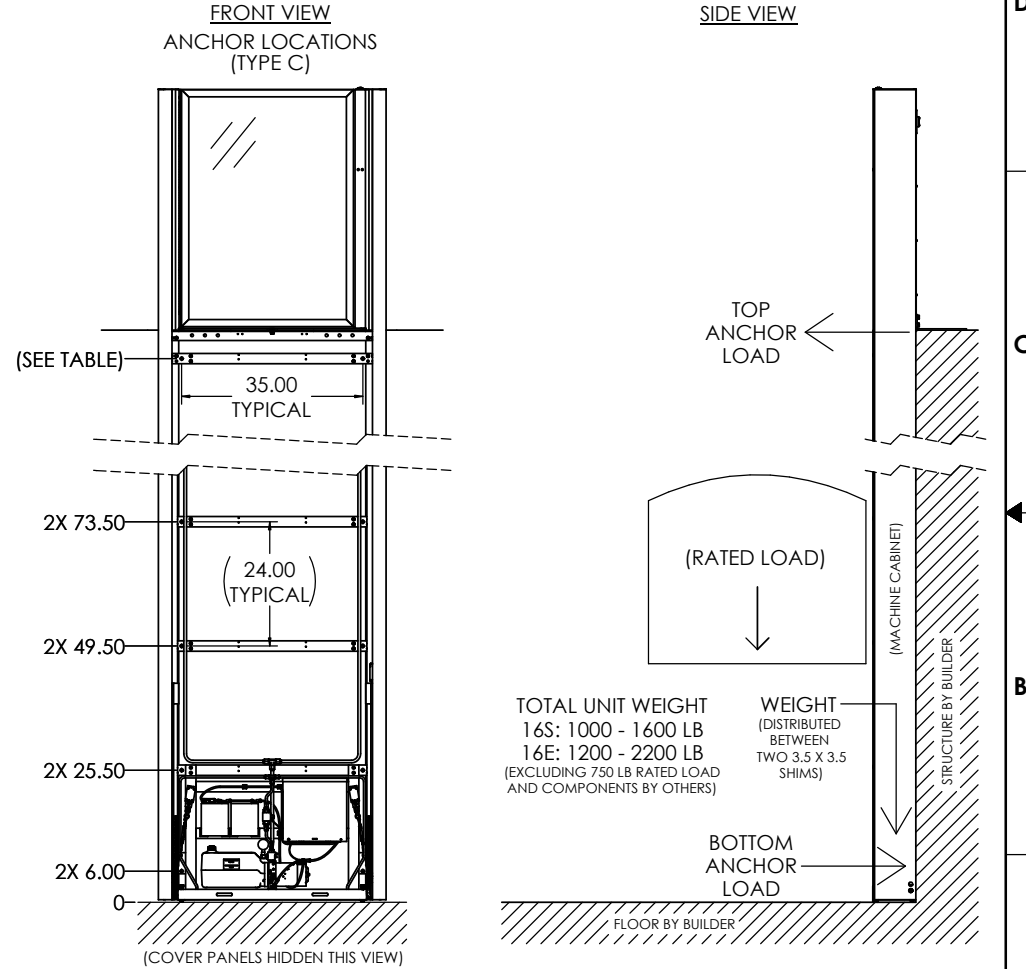

TOTAL UNIT WEIGHT  
16S: 1000 - 1600 LB  
16E: 1200 - 2200 LB  
(EXCLUDING 750 LB RATED LOAD AND COMPONENTS BY OTHERS)

WEIGHT (DISTRIBUTED BETWEEN TWO 3.5 X 3.5 SHIMS)

<small>INTERPRET DIMENSIONS AND TOLERANCES IN ACCORDANCE WITH ASME Y14.5M-1994 UNLESS OTHERWISE SPECIFIED DIMENSIONS ARE IN INCHES (MM) TOLERANCES ANGLES ±.4°</small>		<small>DATE</small> 8-26-20		<small>F.O. BOX #0020 TUCSON, ARIZONA 85717-0020</small>			
<small>DRAWN BY</small> S. APPLEBY	<small>CHECKED</small> 	<small>DATE</small> 8-26-20	<small>SCALE</small> 	<b>CLARITY LOADING STRAIGHT THROUGH</b>			
<small>DO NOT SCALE DRAWING.</small>				<small>APPROVED</small> By Phillip Brobeck at 9:45 am, Sep 17, 2020			
<small>SCALE</small> 1/12	<small>FSCM NO.</small> D 08992	<small>DWG. NO.</small> CLARITY LOADING	<small>REV</small> E	<small>SHEET</small> 1 OF 3			

### ANCHOR LOCATION TYPE: A

**ANCHORS PROVIDED - FOR CONCRETE LANDINGS ONLY:**

3X 1/2" X 2" DROP-IN CONCRETE ANCHORS, 1/2-13 INTERNAL THREAD  
 (EX: SIMPSON STRONG-TIE P/N DIAB50, DIA506SS, OR DIA50SS)

3X 1/2-13 X 1" FLAT HEAD SCREWS

(FILLERS FOR ANCHOR HOLES PROVIDED FOR WOOD LANDINGS)

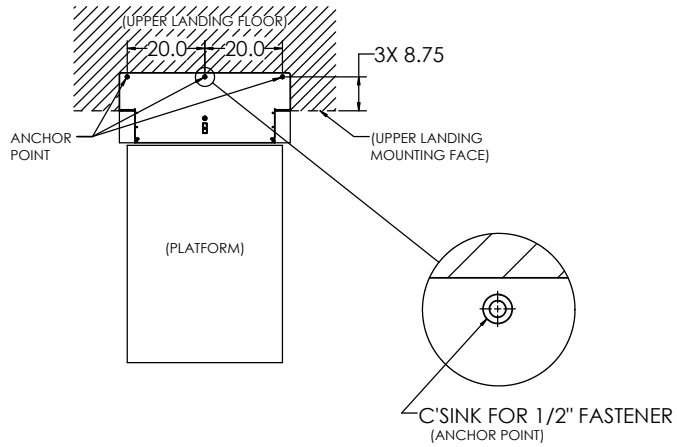

### ANCHOR LOCATION TYPE: D

(HOLLOW LANDING PACKAGE [H.L. PKG] ONLY)

**ANCHORS PROVIDED - FOR NORMAL-WEIGHT CONCRETE FLOOR ONLY:**

2X 1/2" X 2" DROP-IN CONCRETE ANCHORS, 1/2-13 INTERNAL THREAD

(EX: SIMPSON STRONG-TIE P/N DIAB50, DIA506SS, OR DIA50SS)

2X 1/2-13 X 1" FLAT HEAD SCREWS

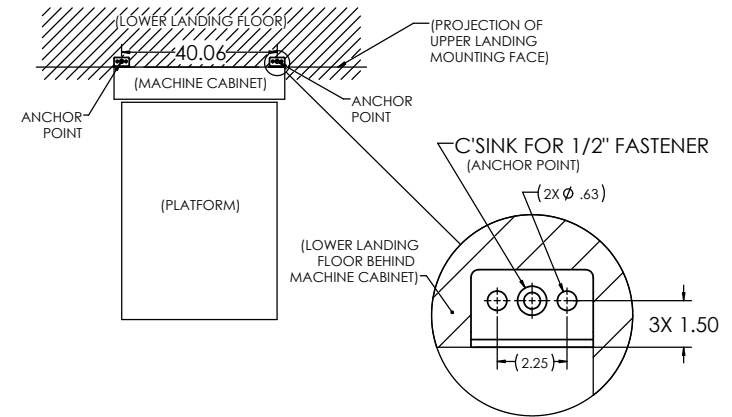

### ANCHOR LOCATION TYPE: C

**ANCHORS PROVIDED - FOR CONCRETE OR WOOD STRUCTURES:**

2X (EACH) 1/2" X 4" CONCRETE ANCHORS

(EX: SIMPSON STRONG-TIE P/N THD50400H, THD50400H6SS, OR THD50400H4SS)

2X (EACH) 1/2" X 4" LAG SCREWS FOR WOOD (INDOOR ONLY)

(SEE NEXT SHEET FOR SUGGESTED WALL CONSTRUCTION)

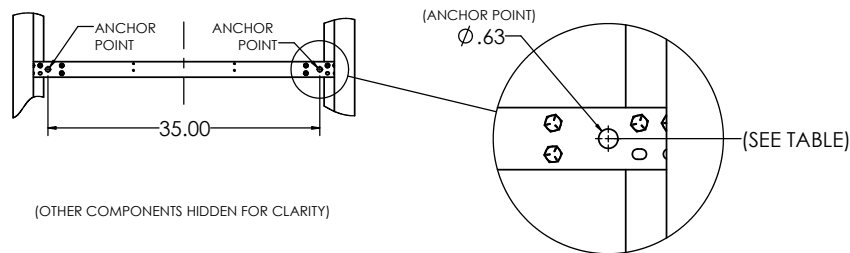

### ANCHOR LOCATION TYPE: F

(CLARITY 16E ONLY)

**ANCHORS PROVIDED - FOR CONCRETE OR WOOD FLOOR:**

2X 1/2" X 2" DROP-IN CONCRETE ANCHORS, 1/2-13 INTERNAL THREAD

(EX: SIMPSON STRONG-TIE P/N DIAB50, DIA506SS, OR DIA50SS)

2X 1/2-13 X 1" SCREWS

2X 1/2" X 4" LAG SCREWS FOR WOOD (INDOOR ONLY)

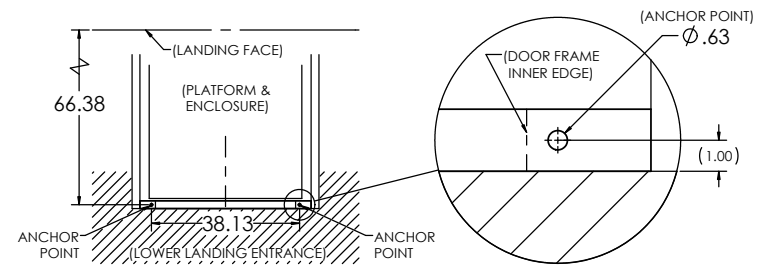

REV	FSCM NO.	DWG. NO.	REV
D	08992	CLARITY LOADING	E
SCALE	1/12	RELEASE DATE	SHEET 2

8

7

6

5

4

3

2

1

REVISIONS				
ZONE	REV.	DESCRIPTION	DATE	APPROVED

### ANCHOR LOCATION TYPE: B

**ANCHORS PROVIDED - FOR WOOD STRUCTURES ONLY:**  
6X 1/2" X 4" LAG SCREWS FOR WOOD (INDOOR ONLY)

D

D

(UPPER LANDING GATE AS VIEWED FROM PLATFORM)

UPPER LANDING F.F.  
(UPPER LANDING GATE HIDDEN)

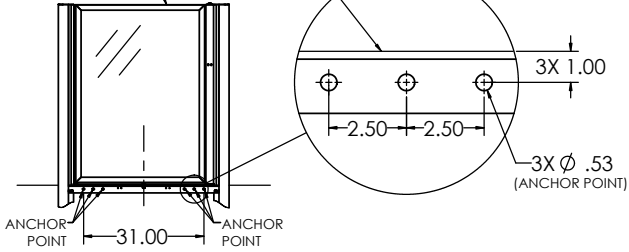

C

C

B

B

A

A

SIZE <b>D</b>	FSCM NO. 08992	DWG. NO.	REV <b>E</b>
SCALE 1/12		RELEASE DATE	SHEET 3

## CLARITY LOADING

8

7

6

5

4

3

2

1